

Mounting set

MHV-BT-F07-G17



- Simple mounting
- No hole required in drive shaft
- Hand lever included
- All-in-one stainless steel solution
- Conforming to standards
- Adjustable in height

Adjustable assembly set for sizes F07 manual operated valves according to EN ISO5211, square shaft G= 17 mm, minimum height 19 mm

Dimensions

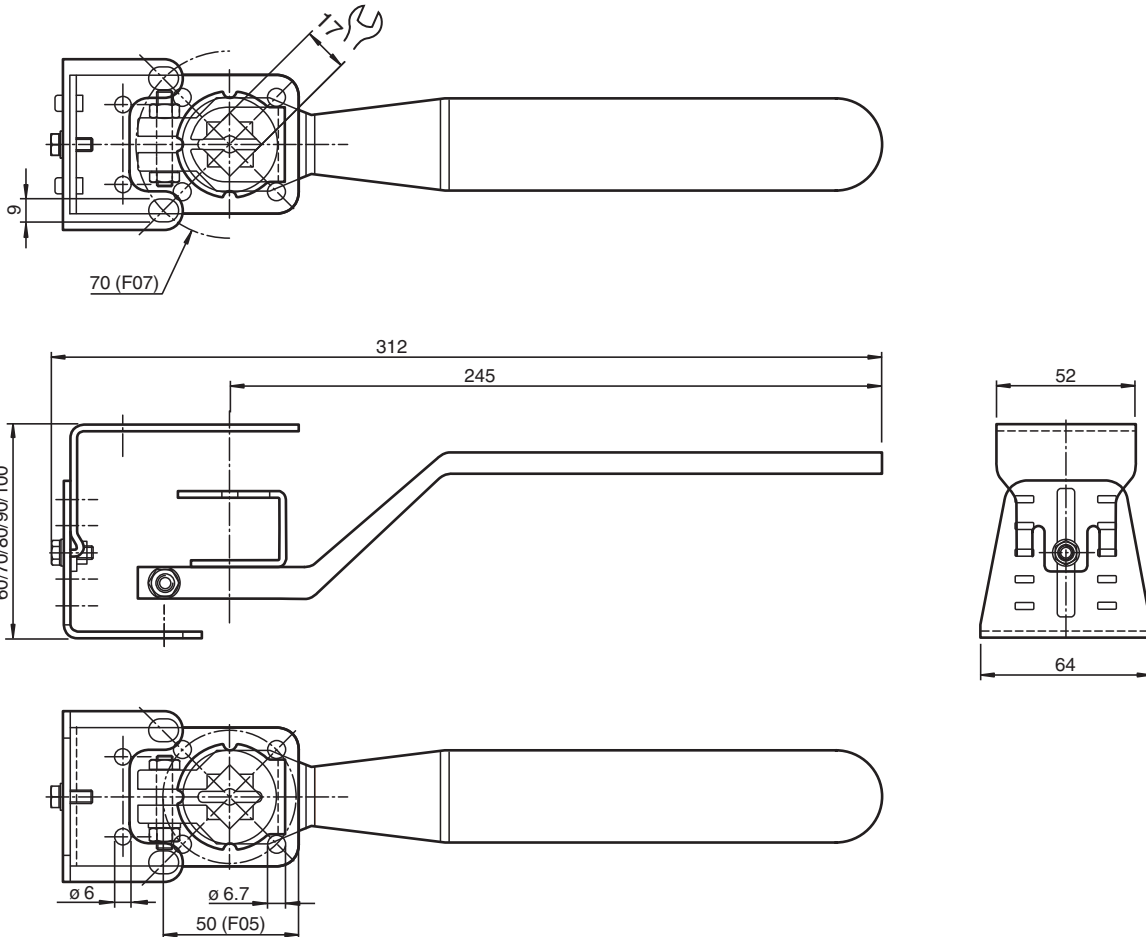

Technical Data

General specifications

Release date: 2023-01-23 Date of issue: 2023-01-23 Filename: 70131303_eng.pdf

Refer to "General Notes Relating to Pepperl+Fuchs Product Information".

Pepperl+Fuchs Group
www.pepperl-fuchs.com

USA: +1 330 486 0001
fa-info@us.pepperl-fuchs.com

Germany: +49 621 776 1111
fa-info@de.pepperl-fuchs.com



Singapore: +65 6779 9091
fa-info@sg.pepperl-fuchs.com

PF PEPPERL+FUCHS

Technical Data

Suitable sensors and	Double sensors, -F25 series with actuator BT32... Double sensors, -F25K series with actuator BT32... Double sensors, -F31 series with actuator BT65... Double sensors, -F31K series with actuator BT65... Double sensors, -F31K2 series with actuator BT65...
Standard conformity	
Standards	DIN EN ISO 5211 / DIN 3337
Mechanical specifications	
Material	stainless steel 1.4301 / AISI 304 for plates and sheet metal bending parts Stainless steel 1.4305 / AISI 303 for shaft Stainless steel 1.4408 / AISI 316 for handle
Mass	663 g
General information	
Note	For the mounting set, an adapter plate and depending on this, and further accessories must be ordered.

Matching System Components

	MHV-BT-F25/F31	Adapter plate for double sensors -F25/-F31 series
	MHV-BT-F31K/F31K2	Adapter plate for double sensors F31K/-F31K2 series

Release date: 2023-01-23 Date of issue: 2023-01-23 Filename: 70131303_eng.pdf